

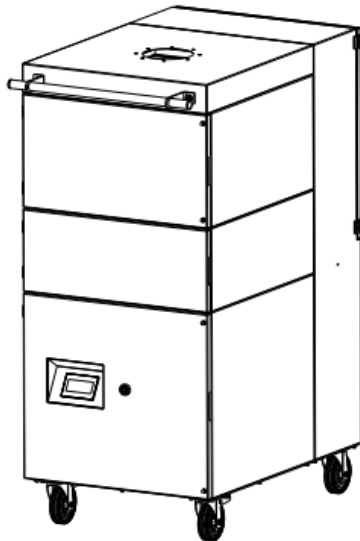

Operating instructions

(Translation of the original operating instructions)

CartMaster 1 IFA



CartMaster 2 IFA

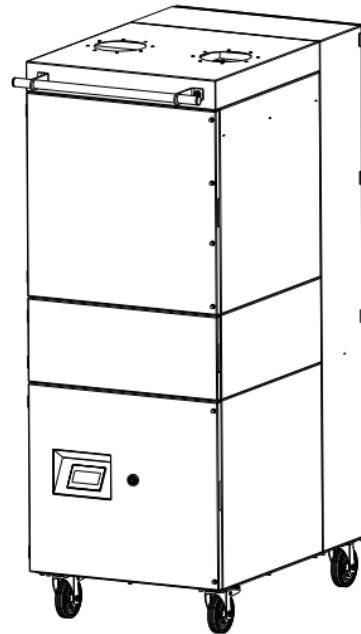



Table of contents

1 General	3
2 Description of the system elements	4
2.1 Illustration of the system elements	4
2.2 Functionality of the system	5
2.3 Intended use	6
2.4. Residual risk	6
3 Safety instructions	7
3.1 Definition of the hazard symbols	7
3.2 General safety instructions	7
4 Storage, transport and installation of the device	8
5 Commissioning	9
5.1 Connecting an extraction element	9
5.2 Electrical connection	10
5.3 Coating of the filter cartridges with cartridge protection	10
5.4 Connecting the compressed air supply	11
5.4.1 Compressed air supply for the cleaning of the filter cartridges	11
6 Operating the system	12
6.1 Explanation of the operating elements	12
7 Maintenance	13
7.1 Reset to maintenance state	14
7.2 Cleaning the filter cartridges	14
7.3 Replacing the filter cartridges	15
7.4 Emptying the dust collecting tank	20
7.5 Draining the condensate	21
7.6 Coating of new filter cartridges with cartridge protection	21
8 Dismantling / Disposal	22
9 Diagnostics and troubleshooting	23
10 List of spare parts	24
11 Technical data	25
12 EC declaration of conformity	26
13 Training protocol	27
14 Maintenance intervals	28
14.1 Usage-related maintenance	28
14.2 General maintenance	28
14.2.1 Visual inspection of the device	29
14.2.2 Visual inspection of the pneumatic pipes	29
14.2.3 Functional test of the device	30
14.2.4 Electrical test of the electrical lines and earthing connections	30

1 General

Congratulations on purchasing the product from TEKA.

Our engineers ensure that our devices reflect the state of the art through continuous development. Nevertheless, misuse or misconduct can endanger your safety. Please observe the following for a successful use of the device:

	<p>Only authorised and instructed personnel can carry out transport, operation, maintenance and repair of the device. The operator must ensure that the operating personnel take note of these instructions.</p> <p>Please read these instructions before operating the device, and observe the safety precautions to avoid injury!</p> <p>Store this manual in a safe place! These instructions are to be regarded as a component of the product!</p> <p>Adhere to all product notes!</p> <p>Modifications or conversions that the operator carries out at the device without the consent of the manufacturer, can lead to new safety hazards or to the loss of warranty claims.</p> <p>Observe the manufacturer's instructions. Contact the manufacturer in case of any uncertainty: Tel: +49 2541-84841-0 E-mail: info@teka.eu</p>
-----------------------------------------------------------------------------------	-----------------------------------------------------------------------------------------------------------------------------------------------------------------------------------------------------------------------------------------------------------------------------------------------------------------------------------------------------------------------------------------------------------------------------------------------------------------------------------------------------------------------------------------------------------------------------------------------------------------------------------------------------------------------------------------------------------------------------------------------------------------------------------------------------------------------------------------------

2 Description of the system elements

2.1 Illustration of the system elements

Installation example:

CartMaster 1 IFA:

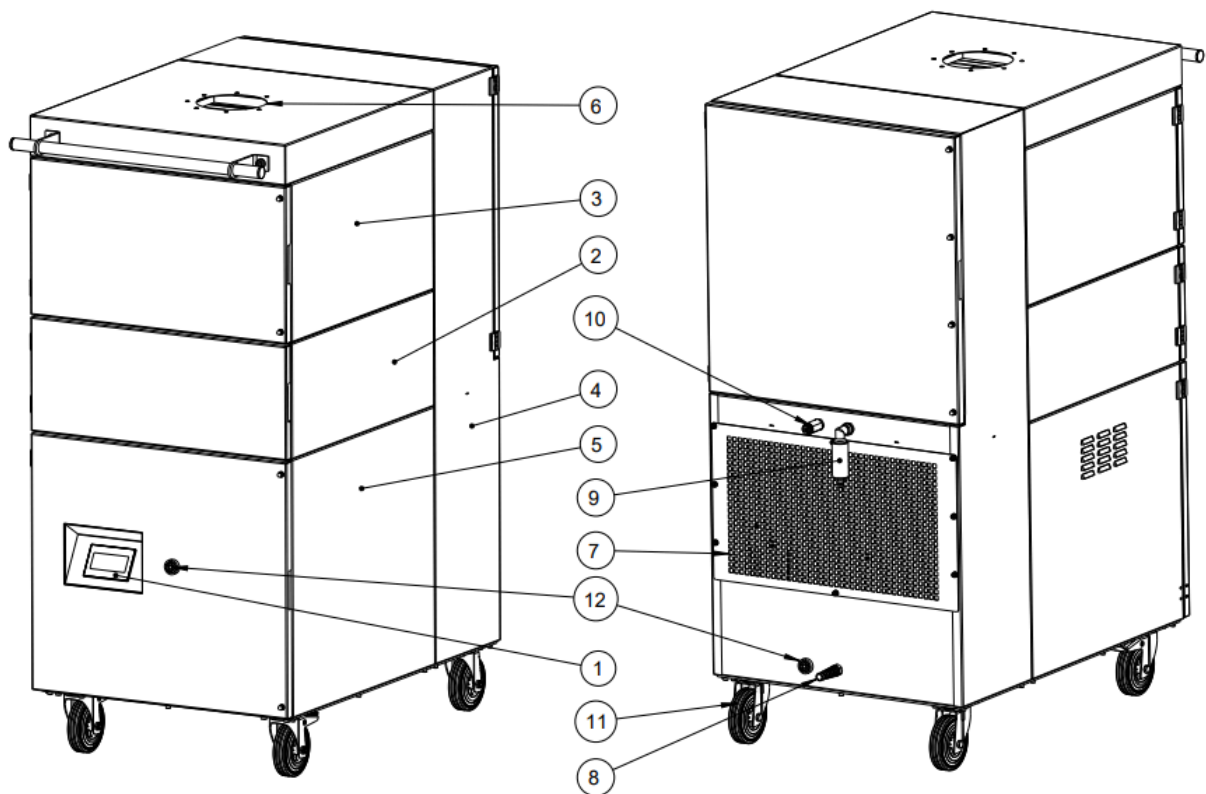

Z.Nr. 20062708

Pos.1	Operating panel of the control	Pos.8	Exhaust grille
Pos.2	Dust collecting housing	Pos.9	Mains cable with plug
Pos.3	Filter housing	Pos.9	Connection for compressed air
Pos.4	Cleaning housing	Pos.10	Drain valve for compressed air
Pos.5	Fan housing	Pos.11	Swivel castor
Pos.6	Suction nozzle	Pos.12	Signal horn

CartMaster 2 IFA:

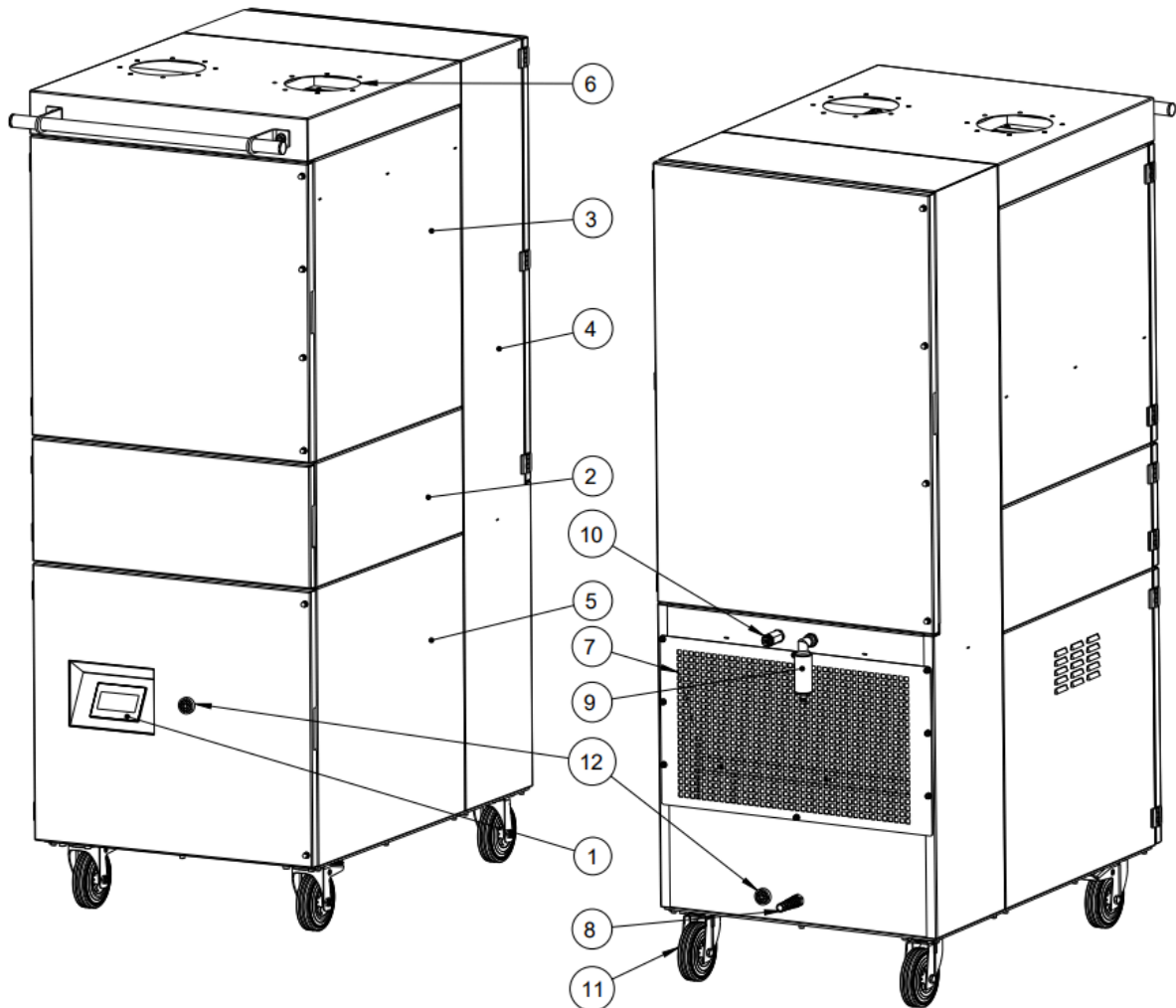

Z.Nr. 20061702

Pos.1	Operating panel of the control	Pos.8	Exhaust grille
Pos.2	Dust collecting housing	Pos.9	Mains cable with plug
Pos.3	Filter housing	Pos.9	Connection for compressed air
Pos.4	Cleaning housing	Pos.10	Drain valve for compressed air
Pos.5	Fan housing	Pos.11	Swivel castor
Pos.6	Suction nozzle	Pos.12	Signal horn

2.2 Functionality of the system

The filter unit serves to suck off and filter polluted air (according to the intended use). The air is purified on the surface of the filter cartridge in the filter section of the unit. The separated dust is collected in a dust collecting tank. An automatic filter monitoring indicates when a cleaning or a replacement of the filters is necessary. The purified air is led back into the working room via an exhaust air grille.

2.3 Intended use

The device is intended for commercial use. If the device is made publicly accessible, it must never be operated unsupervised by authorized personnel, authorized by the operator.

The filter unit is intended for extraction and filtration of dusts and fumes that result from thermal joining and cutting of metals. The filter unit is amongst others suitable for separating welding smokes of unalloyed and alloyed steels as well as of high-alloy chromium-nickel steels and therefore meets the highest welding fume separation category "W3" according to DIN EN ISO 21904-1 / -2.

	WARNING
	<p>Improper use can damage parts and be a danger to life and limb! The device must not be used for the extraction of oil-laden welding fume, explosive dust and gases, hybrid mixtures, glowing or burning substances, gases, water, etc. The device must not be operated in explosive zones.</p> <hr/> <p>Dangers arising from fire. If the sucked medium is combustible fume or dust, the operator must determine beforehand which fire protection measures are to be taken.</p>

2.4. Residual risk

	CAUTION
	<p>Danger due to possible hazardous materials in the exhaust air flow. Because the unit does not monitor the quality of the air in the exhaust air flow, we recommend that you always guide the exhaust air flow exiting our unit to areas (e.g. to the outside into the open air) in which there is no danger to any living being. To do this, it is necessary to fit a suitable exhaust air line at the filter unit.</p>

3 Safety instructions

3.1 Definition of the hazard symbols

The device is constructed according to the state of the art and the recognised safety regulations. Nevertheless, during use threats to life and limb of the user or other persons may arise. The impairment of the machine or other property are also possible. In these instructions we warn by using corresponding indications.

	WARNING WARNING These instructions are made in case of risks that can lead to <u>injury or death</u> .
-----------------------------------------------------------------------------------	----------------------------------------------------------------------------------------------------------------------------

	CAUTION CAUTION These instructions are made in case of risks that can lead to <u>injury</u> .
-----------------------------------------------------------------------------------	-------------------------------------------------------------------------------------------------------------------

	NOTICE NOTICE These instructions are made in case of risks that can lead to <u>material damages</u> .
------------------------------------------------------------------------------------	---------------------------------------------------------------------------------------------------------------------------

	Information notes are no hazard warnings; they call attention to useful information.
-------------------------------------------------------------------------------------	--------------------------------------------------------------------------------------

3.2 General safety instructions

	WARNING Dangers arising from improper use / unauthorised operations. The operator must ensure that their authorised personnel are familiar with all the safety indications in this manual in advance. The operator is responsible for ensuring that all work is carried out by authorised and qualified personnel. We therefore recommend using the training protocol on the last page for that purpose (see chapter "Training protocol"). Laymen are allowed to operate the device after having received the necessary instructions. But they are not allowed to carry out any installation, repair or maintenance work. Dangers arising from fire. In case of fire, if possible, switch the unit immediately off or disconnect it from the power supply. Fire extinguishing measures which the operator is obliged to determine beforehand must be initiated immediately.
-------------------------------------------------------------------------------------	------------------------------------------------------------------------------------------------------------------------------------------------------------------------------------------------------------------------------------------------------------------------------------------------------------------------------------------------------------------------------------------------------------------------------------------------------------------------------------------------------------------------------------------------------------------------------------------------------------------------------------------------------------------------------------------------------------------------------------------------------------------------------------------------------------------------------------------------------------------------------------------------------------------

	WARNING
	<p>Dangers arising from electricity. The operator must ensure that electrical plants and equipment are only built, modified and maintained by a qualified electrician or under the direction and supervision of a qualified electrician. Do not work on components if you are not sure that these are disconnected. If necessary, disconnect the device from the electric power supply and secure it against unauthorized restarting.</p>

4 Storage, transport and installation of the device

	WARNING
	<p>Risk of injury from tilting or unmounted components when stored or transported. The device must be secured against tilting and slipping when it is stored or transported. Do not stand under or next to the floating load. Lift trucks, forklift trucks and transport cranes must have a sufficient minimum load bearing capacity. Pay attention to uneven grounds during the transport. Avoid jerky pushing.</p> <hr/> <p>Dangers arising from tilting or functional impairments at its destination. The unit may only be set up on a suitable surface. The surface must be vibration-free and horizontal. The operator must check the bearing capacity of the surface. As soon as the unit has reached its intended destination, the brakes of the castors must be activated.</p>

	NOTICE
	<p>Damage or functional impairment of the unit due to climatic influences. The unit must be stored in a dry place and protected against moisture during transport. As a matter of principle, the filter unit is not designed to be installed outside.</p>

5 Commissioning

	WARNING
<p>Dangers arising from a defective condition of the unit. Make sure that the measures described in this chapter are completed before the commissioning of the unit. All doors of the unit must be closed and all necessary connections must be attached before turning the unit on. Do not operate the unit if any components are defective, missing or damaged. Check the orderly condition of the unit before switching it on. The unit must not be operated without a filter element.</p>	

	NOTICE
<p>Damaged supply lines. Make sure that the supply lines are protected against damage by forklift trucks and similar events. Protect all supply lines from heat, moisture, oil and sharp edges.</p>	

5.1 Connecting an extraction element

For extracting the contaminated air - according to the intended use - the provided extraction element (e.g. suction arm, suction hose, ...) must be connected at the suction nozzle (see chapter 2.1).

	The assembly of a suction arm is described in the separate operating manual.
-------------------------------------------------------------------------------------	------------------------------------------------------------------------------

When using a detection element with extraction hood, the extraction hood must track the welding seam, possibly taking advantage of the thermally induced welding fume movements.

CAUTION However, it is important to ensure that connections between the workpiece and the extractor hood (and generally between the workpiece and filter device) are avoided, so that, if necessary, the welding current cannot flow back through the protective conductor of the filter device to the welding machine.

5.2 Electrical connection

	CAUTION Health hazard arising from unintentional cleaning processes. Switch on the control only if the unit is in operational condition.
-----------------------------------------------------------------------------------	--------------------------------------------------------------------------------------------------------------------------------------------------------------

	NOTICE Electric malfunction possible in cause of an incorrect power supply. Pay attention to the admissible supply voltage. Please observe the specifications on the type plate.
-----------------------------------------------------------------------------------	------------------------------------------------------------------------------------------------------------------------------------------------------------------------------------------------------

- Reconnect the mains cable (see chapter 2.1) to the power supply.
- Make sure that the fan impeller rotates in the required direction when switching it on for the first time. If not, it results in a low extraction capacity. For visual inspection, there is a sticker attached to the bottom of the dust collecting housing (see chapter 2.1). For the connection points of 400V and 500V the rotating field might be incorrectly set and must be changed, if necessary. Briefly switch the device on and off. The fan slowly starts running and the rotation direction can be compared to the sticker.



CAUTION When the fan rotates in the wrong direction, the extraction capacity is reduced.

5.3 Coating of the filter cartridges with cartridge protection

For a longer service life of the filter cartridges we recommend to coat them with a cartridge protection. The coating can only be carried out during the commissioning at the operation site. When the operator orders and installs new filter cartridges, we recommend to also coat them before the commissioning.

	Please read and refer to "Coating of new filter cartridges with cartridge protection" in the chapter "Maintenance". There you can also find a description of the operating method of the cartridge protection.
-------------------------------------------------------------------------------------	----------------------------------------------------------------------------------------------------------------------------------------------------------------------------------------------------------------

5.4 Connecting the compressed air supply

	NOTICE
	<p>The compressed air must be dry and oil-free. According to ISO 8573-1:2010 the compressed air quality must at least meet: [7:4:4]</p> <ul style="list-style-type: none">→ Partikle size: <math><40\mu\text{m}</math>→ Pressure dew point: $\leq +3^{\circ}\text{C}$→ Oil content: $\leq 5\text{mg}/\text{m}^3$

5.4.1 Compressed air supply for the cleaning of the filter cartridges

The filter cartridges of the system are automatically cleaned. Cleaning is carried out pneumatically via a built-in compressed air tank.

	Without compressed air supply the filter cartridges will become dirty very quickly.
-----------------------------------------------------------------------------------	-------------------------------------------------------------------------------------

- The external compressed air supply must be assured with an approved compressed air hose. For the connection to the device, the compressed air hose must be equipped with a quick coupling for an insert sleeve DN 7.2.

NOTICE The compressed air must be dry and oil-free.

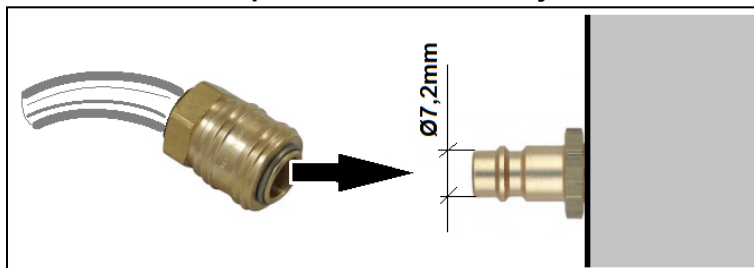

- The operating pressure of the compressed air supply must be a minimum of 3 bars and maximum of 4 bars.

NOTICE In case of the pressure being too low, the compressed air tank does not reach quickly enough the operating pressure for the following cleaning. There is a risk of material damage when the pressure is too high.

- Connect the compressed air hose to the insert sleeve (see chapter 2.1).

6 Operating the system

6.1 Explanation of the operating elements

 Control functions, setting options for programs, menu navigation, error messages, etc. are described in the enclosed operating manual of the unit control. There is also an explanation of the elements of the control panel.

Operating elements for status and error messages		
Representation	Designation	Description / function
	Signal horn	Honking signals that the unit signals an error. Please refer to the error message shown on the display of the control.

According to the settings of the control "ControlUnit" there can be automatic postcleanings of the filter cartridges when the device is turned off. To avoid dust escaping from the extractor cowl of the suction arm, the throttle valve of the extractor cowl must always be closed when the device is turned off.

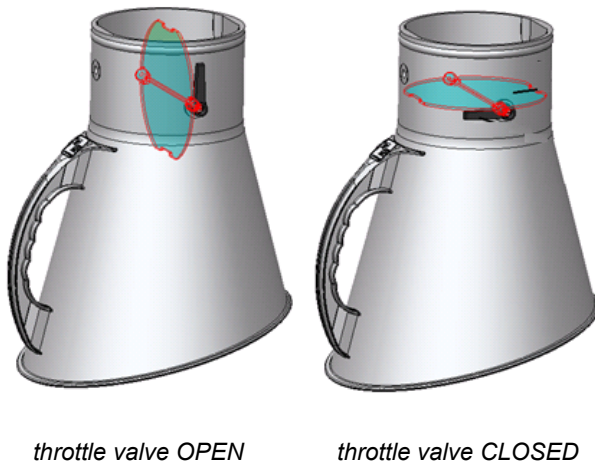

7 Maintenance

In accordance with national regulations, the operator is obliged to carry out repeat and functional tests. Unless otherwise specified by national regulations, we recommend regular visual inspections and functional tests of the device as described in the chapter "Maintenance intervals".



You find the chapter "Maintenance intervals" at the end of the document. The general maintenance (visual inspection, etc.) is also explained there.

In the chapter "Maintenance intervals" there is information on the maintenance intervals of the filter elements. But these are only recommendations. Depending on the application (multi-shift operation, dust generation, ...) it may be necessary for the operator to change the maintenance intervals.

In this chapter the maintenance work which is caused by wear caused during operation is described.



WARNING

Work on the open system entails the risk of electrical shock or accidental restart the system. Both pose a danger to life and limb.

When cleaning and servicing equipment during the replacement of parts or when changing to another function, set the device to maintenance condition first (see chapter "Reset to maintenance state").

A recommissioning of the device must only occur if it is ensured that the device is functionally equivalent to the original state.



CAUTION

Hazards to the respiratory tracts are possible due to contact with contaminated filter elements.

All maintenance work must only be carried out in well-ventilated rooms and while wearing an appropriate respiratory mask! We recommend: respiratory protection half mask DIN EN 141/143 protection level P3. For all maintenance work ensure a cautious handling of filter elements and components in order to avoid whirling up dust.



The operator is obliged to store and dispose of the collected dust in accordance with national or regional regulations. For all maintenance or cleaning work please refer to the applying environmental regulations. Pollutants and filter elements must be disposed of or stored according to the regulations as well. If you have any doubts, we recommend contacting a disposal contractor in your area.

7.1 Reset to maintenance state

- Switch off the unit. Unplug the mains plug. Secure the unit against unauthorized restarting during maintenance.
- Disconnect the compressed air hose of the external compressed air supply from the insert sleeve (see chapter 2.1).
- Empty the compressed air tank by opening the drain valve (see chapter 2.1) with a suitable screwdriver. Minor quantities of condensation water can leak out when opening the drain valve. Close the drain valve when the compressed air tank is entirely empty.
CAUTION When opening the drain valve a jet of compressed air can occur.
- After completion of all maintenance work the unit can be reconnected to the power supply and the external compressed air supply.

7.2 Cleaning the filter cartridges

	CAUTION
<p>A sudden jet of compressed air and huge amounts of whirled up dust are possible due to an automatic cleaning with an opened service door.</p> <p>During the operation of the device, the service door of the filter housing must not be opened. The same applies to the ready to operate condition (standby) as there is also the possibility of an automatic cleaning (subsequent cleaning).</p>	

The filter cartridges are reusable filters and can be cleaned. The cleaning of the filter cartridges is automatically carried out.

The degree of pollution of the filter cartridges is electronically monitored. In order to assure the required extraction capacity of the device, the cleaning of the filter cartridges starts automatically when a preset differential pressure value is reached. If the preset differential pressure value is not undercut after the cleaning of the filter cartridges, another cleaning starts. The filter unit remains in operation during the automatic cleaning. The compressed air blast is produced in opposite direction to the intake. The cleaned dust falls downwards in the dust collecting tank.

Depending on the setting of the control unit there can be automatic postcleanings of the filter cartridges even when the unit is switched off.

When the maximal admissible differential pressure value is reached, the device triggers an alarm (see chapter "description of the control elements"). If despite of the automatic cleaning of the filter cartridge the alarm value is not undercut anymore, the filter cartridge must be replaced. (see chapter: "Replacing the filter cartridges").

The differential pressure values in the control unit that initiate a cleaning or a filter alarm are preset values adapted to the filter unit. Please find detailed information concerning the functioning in the enclosed operating instructions of the control unit.







When using the optional extraction elements with a suction hood, their throttle valve must be closed as soon as the device is switched off. Otherwise dust can escape from the suction hood in case of possible automatic subsequent cleanings.





7.3 Replacing the filter cartridges

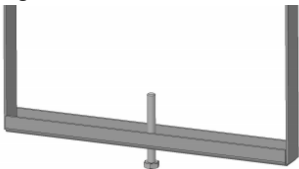

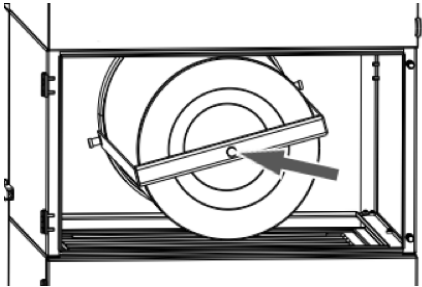

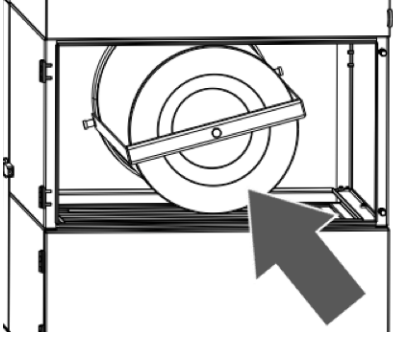
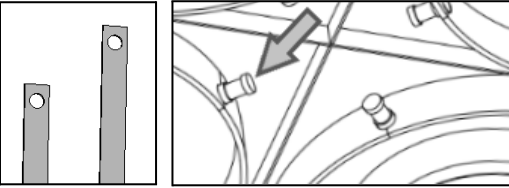

Replacing the filter cartridges becomes necessary when the filter cartridges are saturated with dirt in a manner that despite of the cleaning the filter alarm is triggered again at very short intervals or permanently. (The filter alarm is described in chapter "Cleaning the filter cartridges".)





	CAUTION				
	<p>Whirling up dust is possible due to the polluted filter cartridges. Danger of unintentional automatic cleaning with the unit switched off.</p> <p>The filter cartridges must be cleaned before being replaced. This is done by carrying out 3 manual cleanings via the unit control (see separate operating instructions). The filter unit must be switched off beforehand but without disconnecting the unit from the power supply. After the cleaning, disconnect the filter unit from the power supply and secure it against being switched on again. After cleaning the filter cartridges wait about 5 minutes before opening the service door of the filter housing.</p>				
<table border="1"><tr><td></td><td></td><td></td><td></td></tr></table>					

We recommend to coat new filter cartridges with cartridge protection before the first commissioning. Refer to the chapter "Coating of new filter cartridges with cartridge protection".

<ul style="list-style-type: none"> • We recommend that two people work together to replace the filter cartridges. • We recommend spreading out a protective film in order to keep the area around the unit clean. 	
<ul style="list-style-type: none"> • CAUTION The filter cartridges may only be replaced in well-ventilated rooms and while wearing an appropriate respiratory mask! We recommend: Respiratory protection half mask DIN EN 141/143 protection level P3. • We also recommend using additional protective clothing such as gloves, disposable overalls and protective eyewear. 	
<ul style="list-style-type: none"> • Before replacing the filter cartridges, make sure you have a suitable container (e.g. PE bag) for disposal. • CAUTION The contaminated filter cartridges must be packed in a suitable container (e.g. PE bag). PE bags are available as an option (see spare parts list)! We recommend that you procure disposal bags at an early stage. 	
<ul style="list-style-type: none"> • Open the filter housing's service door. 	<p>10 </p>
<ul style="list-style-type: none"> • Loosen the fixing screw. This is located at the bottom of the cartridge holder. Loosen the fixing screw but do not unscrew it from the cartridge holder. It is important that the cartridge holder is still held loosely. 	<p>17 </p> 

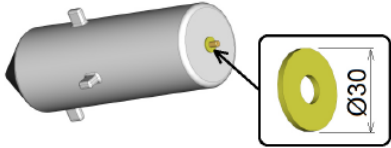
<ul style="list-style-type: none">● Pull the disposal bag over the cartridge holder and filter cartridge.	
<ul style="list-style-type: none">● Unhook the cartridge holder from the cartridge guides.  <ul style="list-style-type: none">● Remove the cartridge holder with the filter cartridge and the disposal bag from the filter housing.	
<ul style="list-style-type: none">● Briefly lift the filter cartridge in order to release it from the cartridge holder.● Next, pull the cartridge holder with little dust on it out of the disposal bag and past the filter cartridge.	
<ul style="list-style-type: none">● Insert the bag into the inside of the filter cartridge at the top.● Then place the filter cartridge on its side.	

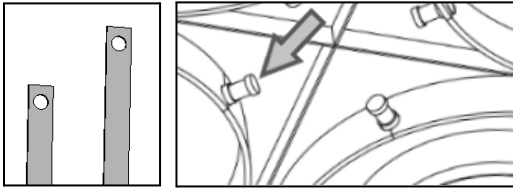
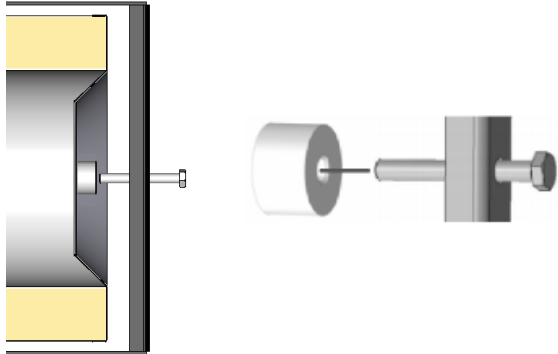
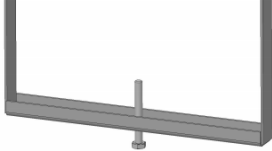
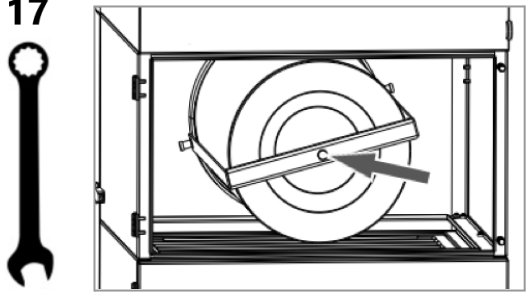
<ul style="list-style-type: none"> • Undo the cylindrical nut. This is located at the base of the filter cartridge. When doing this, do not grip the cylindrical nut directly with your hands but from outside through the bag.  <ul style="list-style-type: none"> • Place the filter cartridge upright again. Remove the cylindrical nut from the bag. 	
<ul style="list-style-type: none"> • Remove the displacer from the filter cartridge. 	
<ul style="list-style-type: none"> • Seal the disposal bag (e.g. with cable ties). <div data-bbox="260 1245 772 1384" style="border: 1px solid black; padding: 5px;">  <p>The operator is obliged to store and dispose of contaminated filter cartridges in accordance with national or regional regulations.</p> </div>	
<ul style="list-style-type: none"> • First of all, remove <u>all</u> the filter cartridges as described in the steps above. • Only then should you start to install the new filter cartridges. <p>NOTICE Only use TEKA replacement filters. Otherwise the correct functioning of the unit is not guaranteed.</p>	

<ul style="list-style-type: none"> Insert the displacer into the new filter cartridge in such a way that the displacer's screw passes through the opening in the base of the filter cartridge. <p>NOTICE Check whether the seal is in contact at the thread of the displacer and that it is undamaged. Otherwise, it is necessary to use a replacement seal (see spare parts list).</p> 	
<ul style="list-style-type: none"> Screw the displacer tight with the cylindrical nut. <p>NOTICE When you do this, the side of the large chamfer (A) of the cylindrical nut must face outwards.</p>	
<ul style="list-style-type: none"> Insert the new filter cartridge in the cartridge holder. When you do this, the fixing screw must engage in the cylindrical nut. Insert the cartridge holder with the new filter cartridge in two of the cartridge guides. 	
<ul style="list-style-type: none"> Screw the fixing screw tight. <p>NOTICE If the fixing screw is not properly tightened then the seal at the top of the filter cartridge may not be pressed on sufficiently.</p> 	<p>17</p> 
<ul style="list-style-type: none"> Close the service door. 	<p>10</p> 

7.4 Emptying the dust collecting tank

The dust collection container must be cleaned after a certain number of operating hours. This range depends on the amount of dust. The dust collecting tank may only be filled up to a maximum of 25%. The filling level has to be proofed at least once a week.

	CAUTION				
	<p>Whirling up dust is possible due to the polluted filter cartridges! Danger of unintentional automatic cleaning with the unit switched off.</p> <p>The filter cartridges must be cleaned before emptying the dust collecting tank. This is done by carrying out 3 manual cleanings via the unit control (see separate operating instructions). The filter unit must be switched off beforehand but without disconnecting the unit from the power supply. After the cleaning, disconnect the filter unit from the power supply and secure it against being switched on again. After cleaning the filter cartridges wait about 5 minutes before opening the service door.</p>				
<table border="1" style="width: 100%;"> <tr> <td style="text-align: center;"> </td> <td style="text-align: center;"> </td> <td style="text-align: center;"> </td> <td style="text-align: center;"> </td> </tr> </table>					

i Before emptying the dust collecting tank hold ready an appropriate container (e.g. PE bag). The bags are optionally available at TEKA, see list of spare parts. We recommend having PE bags in stock.

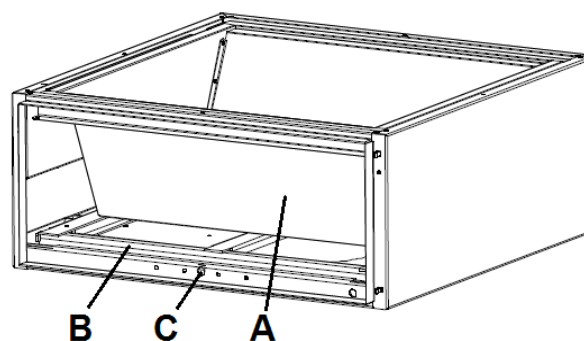

- Open the service door of the dust collecting housing (see chapter 2.1).
- Lower the lifting device (B) by turning the clamping screw (C). Therefore, use the hexagon key that is located on the right of the clamping screw.
- Carefully pull the dust collecting tank (A) out of the housing.
- Close the dust collection bag (e.g. with a cable fastener).
- Remove the dust collection bag and store or dispose of it according to the regulations.

- Place a new dust collection bag in the dust collection container so that the bag is put over the edge of the dust collection container.
- Push the dust collecting tank back into the dust collecting housing.
- Elevate the lifting device by turning the clamping screw so that the dust collection container is pressed tightly against the above housing.
- Close the service door.

7.5 Draining the condensate

Operation with compressed air can result in condensation water being gradually deposited in the compressed air tank. The condensed water must be emptied regularly. The maintenance interval depends heavily on the quality of the compressed air and cannot, therefore, be determined in advance.



	CAUTION
	<p>When opening the drain valve a blast of compressed air is possible. Open the drain valve slowly.</p>

- Empty the compressed air tank by opening the drain valve (see chapter 2.1) with a suitable screwdriver. Let the escaping condensate flow into a suitable container.
- Close the drain valve.

7.6 Coating of new filter cartridges with cartridge protection

Before the first commissioning new filter cartridges can be coated with cartridge protection. The cartridge protection assists against a "caking" of extracted particles on the filter surface and thus prolongs the life of the new filter cartridge.

Unlike with other maintenance work, this step must be carried out with the system switched on and operating. This is necessary to allow the cartridge protection to disperse on the surface of the filter cartridges through suction.

	CAUTION	
	<p>On contact the cartridge protection can be hazardous to the respiratory tract and cause skin irritation or eye irritation. Observe the listed manufacturer instructions provided:</p> <p><i>Handling:</i> Avoid the formation of dust! <i>Storage:</i> Seal the container tightly before storage! <i>Respiratory protect:</i> Dust mask without protection level! <i>Hand protection:</i> Protective gloves in cloth, rubber or leather! <i>Eye protection:</i> Safety glasses with side shields! <i>Body protection:</i> Anti-static work shoes!</p>	

	CAUTION
	<p>During operation of the device an automatic cleaning can take place. This involves the risk of a sudden jet of high-pressure air and excessive dust formation at the point of entry of the cartridge protection.</p> <p>At first make sure that there is no compressed air in the compressed air tank. Please refer to the chapter "Reset to factory settings". Before switching the device back on, disconnect the compressed air hose from the device.</p>

- Provide sufficient cartridge protection. We recommend using **10 grams** for each **square metre** of the **filter surface**. The cartridge protection is available at TEKA (see list of spare parts).
- Choose the capture point in the suction pipe that is the closest to the filter cartridges. E.g. an inspection flap can be used as a capture point.

NOTICE Electrical short-circuit due to LED lighting possible. If the extraction cowl of a suction arm is chosen as an extraction point then this extraction cowl may only be used if it is not equipped with LED lighting. Otherwise, the cartridge protection must not be extracted via the extraction cowl but, for example, via the hose of the suction arm by disconnecting this from the extraction cowl for this period.

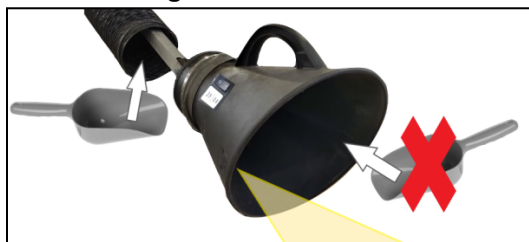



- Switch the device on.
- Let the cartridge protection bit by bit be sucked in via the capture point.

8 Dismantling / Disposal

Only authorised personnel may disassemble the machine.

	WARNING
	<p>Dangers arising from electricity.</p> <p>Before the dismantling of the machine it has to be disconnected from the power supply and all supply lines.</p>

	CAUTION
	<p>Whirling up dust is possible due to the deposited dust.</p> <p>During all work a suitable respiratory protection and protective clothing have to be worn.</p>

	The operator is obliged to store and dispose of the collected dust in accordance with national or regional regulations.
-------------------------------------------------------------------------------------	-------------------------------------------------------------------------------------------------------------------------

9 Diagnostics and troubleshooting

A list of possible system errors is provided in the table.

i	Error messages of the control unit are described in the enclosed operating manual of the control unit.
	Faults indicated by control elements are explained in the chapter "Description of the control elements".

A recommissioning of the device must only occur if it is ensured that the system is functionally equivalent to the original state. Repairs may only be carried out by TEKA personnel or, after consultation with TEKA GmbH, by the personnel authorised by the operator.

Adhere to the instructions in the chapter "Safety instructions" and "Maintenance" when carrying out any repairs. If in doubt, contact our TEKA service department:

Tel: +49 2541-84841-0
E-mail: info@teka.eu

Fault	Cause	Removal
System does not start.	Plug power supply is missing or incorrectly inserted.	Plug connector check power supply / plug in correctly.
	No power at outlet.	Check the mains, remove error if possible.
Dust at the dust collecting tank.	There is too much dust in the dust collection container.	Empty the dust collecting tank.
	The lifting device has not been lift up.	Screw up the lifting device.
	The seal of the dust collecting tank is damaged.	The seal must be replaced.
	The compressed air for the dedusting is set too high.	Reduce the compressed air.
Dust at the service door of the filter housing.	The door is not correctly closed.	Close the door.
	The seal between the service door and filter housing is damaged.	The seal must be replaced.
	The compressed air for the dedusting is set too high.	Reduce the compressed air.
	Escape of dust at the hinge.	The hinge must be reoriented or replaced.

Suction power too low (smoke hardly extracted).	Filter element is saturated.	Replace the filter package, dispose of old filter properly!
	Filter elements are saturated because no compressed air is connected.	Connect compressed air.
	Damage at the extraction elements.	Replace the extraction elements.
	The motor rotates in the wrong direction.	The rotating field of mains connection point must be changed.
	Suction line contracted.	Check and fix.
	Exhaust line contracted.	Check and fix.
	Maybe throttle valves are used in the suction line.	Adjust throttle valves.
The system is very noisy.	The motor rotates in the wrong direction.	The rotating field of mains connection point must be changed.
	The unit is untight.	Check and fix.

10 List of spare parts

Filter element	Article no.
Filter cartridge, Type "BIA-M", 10,0m ² (Ø327 x 600 mm) (CartMaster 1: 1 piece of these filter elements is required for the device) (CartMaster 2: 2 pieces of these filter elements are required for the device)	6160600110008
Disposal elements	Article no.
PE-bag for the disposal of filter cartridges (4 pieces)	10030251702
PE-bag for inserting into the dust collecting tank (10 pieces)	10030250
Cartridge protection	Article no.
"NANNOX P50" for filter cartridges, 400g (in a bucket)	68130000400
"NANNOX P50" for filter cartridges, 100g (in a bucket)	68130000100
Other parts	Article no.
Seal for displacer (Ø30 mm / 1 piece)	9400000000

11 Technical data

Version		CartMaster 1 IFA	CartMaster 2 IFA
Supply voltage	V	400	400
Frequency	Hz	50	50
Type of current	Ph	3	3
engine power	kW	1,1	2,2
Air flow volume max.	m³/h	1860	2500
Air flow volume (possible operation point)	m³/h	1210	2220
Air flow volume min.	m³/h	700	1160
Negative pressure max.	Pa	2900	2800
Protection class		IP54	
ISO class		F	
Filter surface	m²	10	20
Welding fume extraction class (according to EN ISO 21904-1 / -2)		W3	
Width	mm	665	665
Depth	mm	1100	1100
Height	mm	1495	1775
Weight	kg	200	240
Sound pressure level	dB(A)	72	74
Allowed ambient temperature	°C	+5 to +35 (during operations) -10 to +40 (during transport and storage)	
Max. temperature of polluted air at the capture point	°C	+50	
Allowed max. humidity	%	70	
Compressed air supply		dry / oil-free	
Necessary external pressure	bar	see chapter "Connecting the compressed air supply"	

12 EC declaration of conformity

according to the Machinery Directive 2006/42/EG, Annex II, 1 A

TEKA Absaug- und Entsorgungstechnologie GmbH
Millenkamp 9, D-48653 Coesfeld

Tel.: +49 2541-84841-0

E-Mail: info@teka.eu

Internet: www.teka.eu

Designation of the device: CartMaster 1 - IFA / CartMaster 2 - IFA

We hereby declare under our sole responsibility that the product mentioned above, from the serial number A22600010011001 resp. P57300010011001 on, conforms to the following directives:

Machinery Directive: 2006/42/EG

Electromagnetic Compatibility: 2014/30/EC

Pressure equipment directive: 2014/68/EU

RoHS directive: 2011/65/EU

This declaration will become void if the device is exposed to modifications that are not approved by the manufacturer in written form.

Authorized representative for the technical documentation:

TEKA Absaug- und Entsorgungstechnologie GmbH, Millenkamp 9, D-48653 Coesfeld

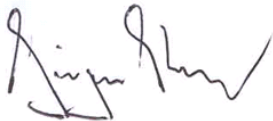

(Jürgen Kemper, managing director)

Coesfeld, 3rd January 2023



13 Training protocol

Designation of the device: CartMaster 1 - IFA / CartMaster 2 - IFA

(This form can be used by the operator to document the training of the employees. Training should be performed by authorized personnel only. Refer to the instructions in Chapter "Safety Instructions")

By his signature, the employee confirms that he has been instructed regarding the following items:

Instruction	completed
Description of the device	
Operation and application of the device	
Explanation of the safety instructions	
Behavior in case of fire	
Explanation of the operation elements	
Change and dedusting of the filter elements	
Emptying of the dust collecting tank	
Appropriate disposal	
Maintenance works / Maintenance intervals	

Name of the employee (legible)	Signature

Introduction through (legible):	
Signature:	

14 Maintenance intervals

14.1 Usage-related maintenance

The described maintenances become necessary through the demands of the system operations. The maintenance intervals are recommendations. Depending on the application (multi-shift operation, dust generation, ...) it may make sense for the operator to change the intervals of maintenance, replacing and cleaning.

Maintenance work must always be documented by means of a protocol.

The approach of the maintenance measures is described in chapter "Maintenance".

Maintenance work	Chapter	Maintenance interval	
		recommended by TEKA	determined by the operator
Cleaning the filter cartridges	7.2	The cleaning of the filter cartridges is automatically carried out by the filter unit and thus is not subject to a maintenance interval.	
Replacing the filter cartridges	7.3	The saturation of the filter cartridges is automatically monitored by the filter unit and thus is not subject to a maintenance interval. The filter unit triggers an alarm when a replacement of the filter cartridges is necessary.	
Emptying the dust collecting tank (or check of fill level)	7.4	weekly	
Draining the condensate	7.5	monthly	

14.2 General maintenance

The described maintenances are independent from the demands of the system operations.

The operator is obliged to carry out repeated inspections and functional tests according to national regulations. If not otherwise covered by national regulations, the described maintenance intervals must be respected.

Maintenance work must always be documented by means of a protocol.

Maintenance work	Chapter	Maintenance interval
Visual inspection of the device	14.2.1	weekly
Visual inspection of the pneumatic pipes	14.2.2	monthly
Functional test of the device	14.2.3	monthly
Electrical test of the electrical lines and earthing connections	14.2.4	annually

14.2.1 Visual inspection of the device

Visual inspection: Observation that there are no visible safety-related defects.

	WARNING Danger arising from the ready to operate condition of the device. Follow the procedure as described in the chapter "Set to maintenance state".
-----------------------------------------------------------------------------------	----------------------------------------------------------------------------------------------------------------------------------------------------------------------------

The following steps must be carried out in the course of the visual inspection:

- Check if all required pipeline elements, cable connections and hoses are connected to the filter unit
- Check all electrical earthing connections and cables for visible damages.
- Ensure that all parts are firmly connected.
- Check all connection points of the filter unit for escaping dust.
- Check all metal parts for corrosion or damages / changes of the coating.
- Check the inner filter area and the filter housing.
- Visual inspection of the control and operating elements as well as the outside running cables for damages.
- Check the dust collecting tank for tightness, check the sealing rubber of the tank.

14.2.2 Visual inspection of the pneumatic pipes

Visual inspection: Observation that there are no visible safety-related defects.

	WARNING Danger arising from the ready to operate condition of the device. Follow the procedure as described in the chapter "Set to maintenance state".
-------------------------------------------------------------------------------------	----------------------------------------------------------------------------------------------------------------------------------------------------------------------------

The following steps must be carried out in the course of the visual inspection:

- Open the service door of the pneumatic housing .
- Carry out a visual inspection of the pneumatic parts.

14.2.3 Functional test of the device

	NOTICE
<p>Possible material damage due to faulty condition of the unit. Carry out a visual inspection before the functional test of the device as described in the previous chapters. The work as described in the chapter “Commissioning” must be finished.</p>	

The following steps must be carried out in the course of the functional test:

- Switch on the device.
- Pay attention to failures or error messages of the control unit. Also refer the separated operating manual of the control unit.
- Pay attention to extraneous noises or vibrations during the device’s operation.
- Carry out a manual dedusting of the filter cartridges. Also refer to the separated operating manual of the control unit.
- Check if within one interval of the filter dedusting the number of dedusting shocks is equal to the number of filter cartridges (in each interval successively every filter cartridge becomes dedusted once).
- Check if dust is escaping from the unit during the dedusting cycle.
- A functional test should always be carried out with a connected / producing machine tool. Check if the collection of the fume or dust is sufficient. (Visual inspection).

14.2.4 Electrical test of the electrical lines and earthing connections

	WARNING
<p>Danger arising from electricity. The operator is responsible for ensuring that all work on electric components is carried out by authorised and qualified personnel.</p>	

The device is subject to regular electrical checks by the operator of the device, and are subject to national standards of the different countries.

The here recommended maintenance interval complies with the in Germany applying "Regulation 3 of the German Social Accident Insurance - Electrical plants and equipment" (formerly known as BGV-A3).

The check must only be carried out by a qualified electrician or a person trained in electrics using suitable measuring and test devices. The scope of testing and the methods must be in line with the respective national standard. All contacts in the control cabinet must be checked for tight fit, and must be readjusted if necessary.